

# Recessed Bath Accessories

## The Executive

### The Combo Holder

The Executive Collection is perhaps the most versatile and diversified in our series of recessed accessories. The edge detail is designed to match the Executive Collection towel caddies and magazine racks. They also match a number of our bathing pools and basins. The combo holders are designed to provide ample space for those items so essential to the shower users personal hygiene.

As with all other Six-Eleven products, this collection is available in Exyte\*, Aluminyx, Granatex and many custom colors.

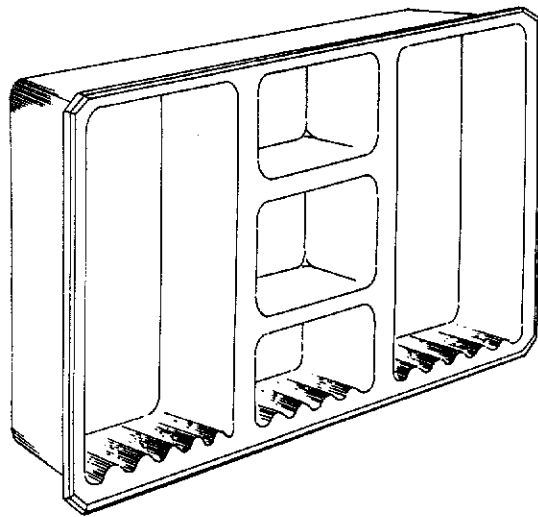

Note that when using the large unit, more than normal stud-to-stud space is needed. Make proper preparations.

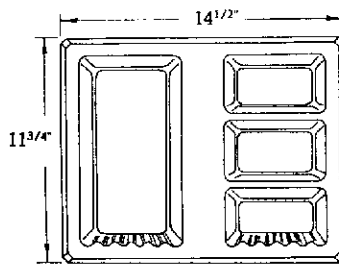

Small

Weight 17 lbs.

Opening Size 13 3/4" x 11"

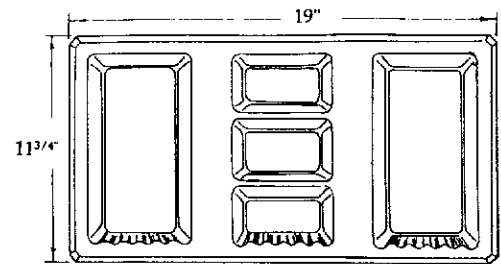

Large

Weight 22 lbs

Opening Size 18 1/4" x 11"

### Soap Holders

These ever so convenient soap holders may be used in the shower or the tub. In some instances, they can be incorporated into the side of our bathing pools.

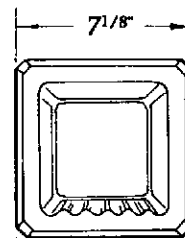
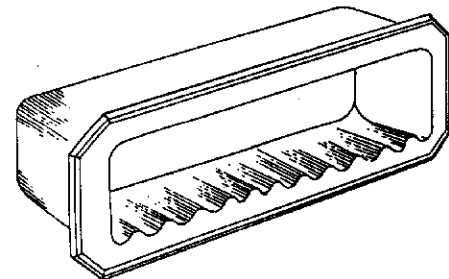

Small

Weight 5 1/2 lbs.

Opening Size 6 1/2" x 6 1/2"

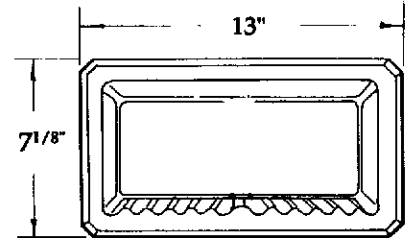

Large

Weight 10 lbs.

Opening Size 12 1/2" x 6 1/2"

### Toilet Paper Holders

A complimenting the total bath environment! Convenient and accessible for even the most cramped water closet areas. Chose from our single or double unit.

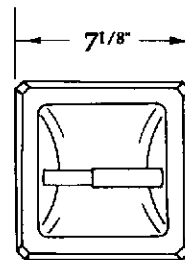
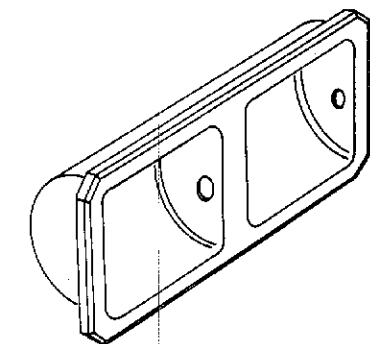

Single

Weight 4 lbs.

Opening Size 6 3/8" x 6 3/8"

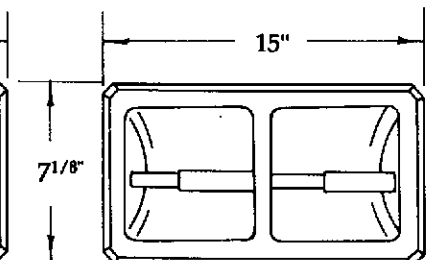

## Collection

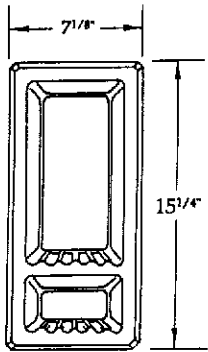
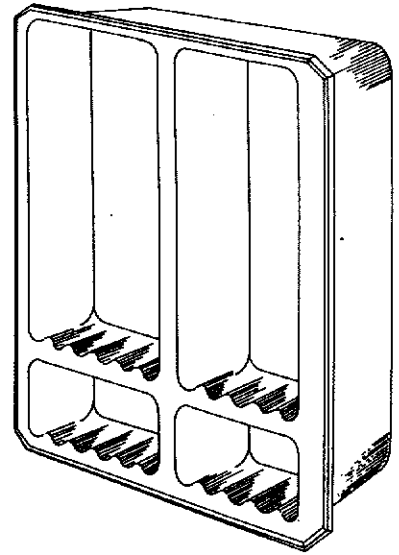

Single Unit  
Weight 11 lbs.  
Opening Size 6<sup>3/8</sup>" x 14<sup>1/2</sup>"

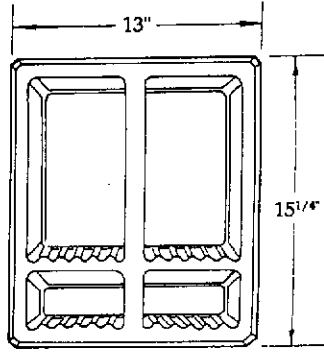

Double Unit  
Weight 21 lbs.  
Opening Size 12<sup>1/4</sup>" x 14<sup>1/2</sup>"

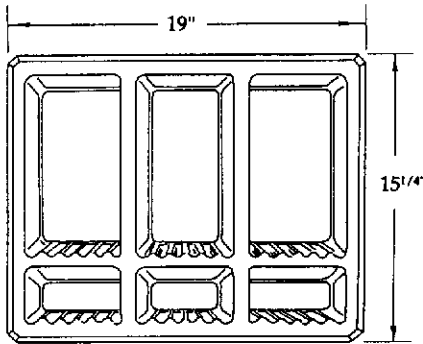

Triple Unit  
Weight 30 lbs.  
Opening Size 18<sup>1/4</sup>" x 14<sup>1/2</sup>"

## Soap & Shampoo Holders

The soap and shampoo holders place your hygiene items within reach in an unobstruent recessed bath accessory. Available in a single, double or triple unit. The real advantage of these and our other accessories is that you can incorporate any number of different units in a single environment to achieve the convenience and sotorage most suitable to your needs.

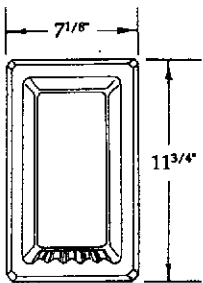

Single Unit  
Weight 8 lbs.  
Opening Size 6<sup>3/8</sup>" x 11"

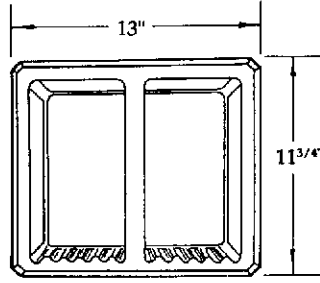

Double Unit  
Weight 15 lbs.  
Opening Size 12<sup>1/4</sup>" x 11"

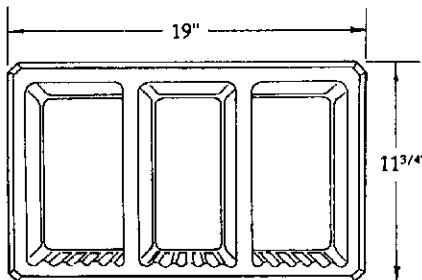

Triple Unit  
Weight 23 lbs.  
Opening Size 18<sup>1/4</sup>" x 11"

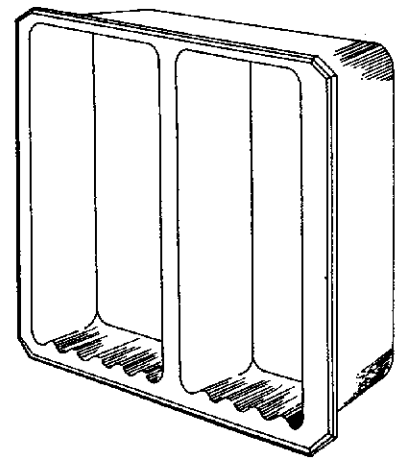

## Shampoo Holders

Clean cut and simple for the user who wishes to store shampoo, conditioner or other items without the soap holder. Available in single, double and triple units. May be combined in any arrangement desired.