

# Vent Hood® WALL MOUNT LINER INSERT SPECIFICATIONS

BPSLD/BHPSLD LINER "H" in part number indicates halogen lighting. This model not available with heat lamps.

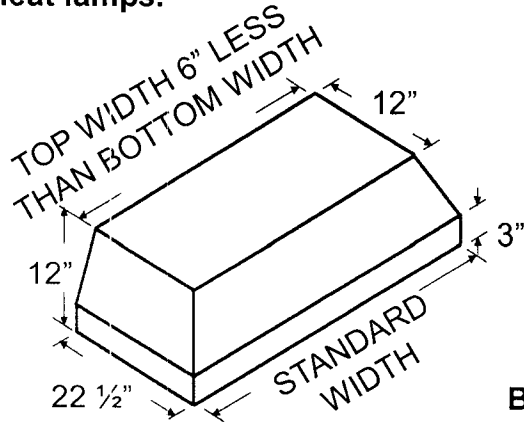

## Standard Widths

- 28 3/8"
- 34 3/8"
- 40 3/8"
- 46 3/8"
- 52 3/8"
- 58 3/8"
- 64 3/8"

## BPSLD/BHPSLD

### Blower Outlet Diagrams (28 3/8" - 52 3/8" Widths)

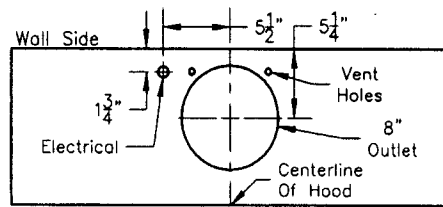

Top View--B200 Dual Blower

### Mounting Height

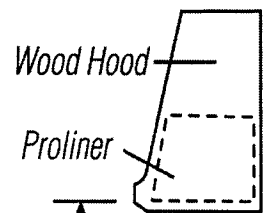

27" - 30"

### Blower Outlet Diagrams (46 3/8" - 58 3/8" Widths)

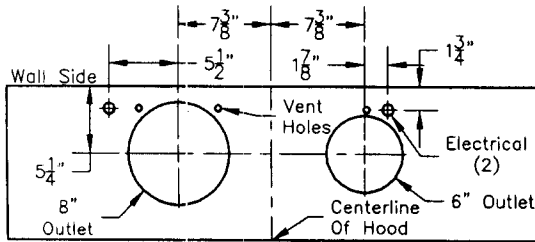

B200 Dual Blower B100 Single Blower  
Top View

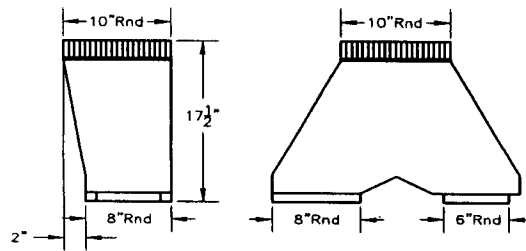

VP562 Transition (Optional) For B300  
(B200 Dual Blower & B100 Single Blower)

36"

### Blower Outlet Diagrams (52 3/8" - 64 3/8" Widths)

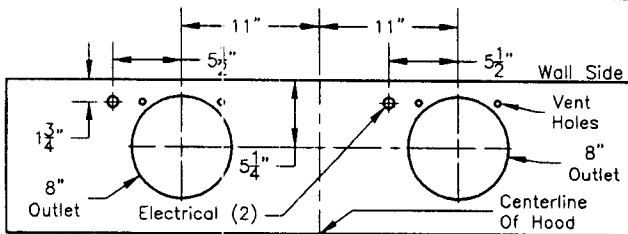

B200 Dual Blower B200 Dual Blower  
Top View

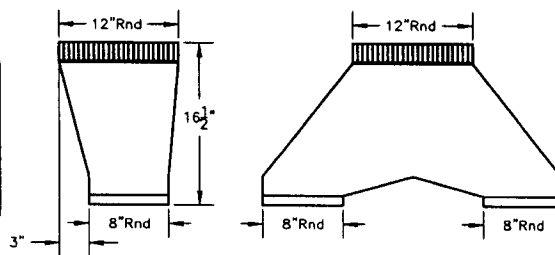

VP563 Transition (Optional) For B400  
(B200 Dual Blower & B200 Dual Blower)

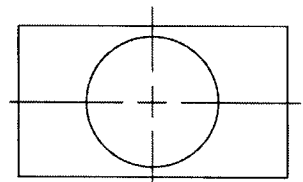

VP562/VP563  
transitions  
center outlet  
over top of hood

### Electrical/Mechanical Specifications For Blower Units

Model	Motor	Type	Volts	Amps	HZ	RPM	CFM SP@0.0"	Equivalent CFM	CFM SP@0.1"	CFM SP@0.2"	CFM SP@0.3"	Minimum Round Duct Size	Square Inches
B100 Single	1/25	Shaded Pole	115	1.7•	60	1550	300	450	286	270	240	6" (or equivalent)	28
B200 Dual	(2) 1/25	(2) Shaded Pole	115	3.4•	60	1550	600	900	572	540	480	8" (or equivalent)	50

● Note: Add .5 amp for each halogen bulb. Equivalent CFM refers to the fact that the Magic Lung blower uses centrifugal filtration units, whereas others use conventional filters. Apply this guideline when comparing blower units made by other manufacturers. Hood is available with fluorescent light (1 for each single or dual blower) or with halogen lights- 24" to 41" 2 lights, 42" to 53" 3 lights, 54" to 66" 4 lights, over 66" 1 light for each 16" hood width.

SPECIFICATIONS SUBJECT TO CHANGE WITHOUT NOTICE Rev. 05/05